

maaxTV

MaaxTV LN5000HD

User's Guide

How to use the LN5000HD set-top box



Contents

1. Safety.....	1
2. Appearance.....	4
3. Rear Panel Connection.....	5
4. Remote.....	7
5. First Time Set-Up.....	9
6. Network Settings.....	10
6.1 Available Networks and Checking Current Network Status.....	10
6.2 Connecting to Cable Network.....	10
6.3 Connecting to Wi-Fi.....	11
7. Video Settings.....	13
7.1 Available Video Interfaces.....	13
7.2 Screen size settings.....	14
8 Specification.....	15
9 Disclaimer.....	16

1 Safety

IMPORTANT SAFETY INSTRUCTIONS

- Read and follow these instructions.
- Heed all warnings.
- Do not use this apparatus near water.
- Clean only with dry cloth.
- Do not block any ventilation openings. Install in accordance with the manufacturer's instructions.
- Protect the power cord from being walked on or pinched particularly at plugs, convenience receptacles, and the point where they exit from the apparatus.
- Unplug this apparatus during lightning storms or when unused for long periods of time.
- Refer all servicing to qualified service personnel. Servicing is required when the apparatus has been damaged in any way, such as the power-supply cord or plug is damaged, liquid has been spilled or objects have fallen into the apparatus, the apparatus has been exposed to rain or moisture, does not operate normally, or has been dropped.
- In ambient temperatures of no more than 27° C (80° F), the normal operating temperature for LN5000HD is between 50° C (122° F) to 60° C (140° F).

IMPORTANT SAFETY CONSIDERATIONS

The LN5000HD set-top box requires careful handling to avoid potential damage to its internal parts. Be sure to follow these requirements during transportation and installation. The plug is the main disconnect device. It shall remain readily accessible and operable. The apparatus shall not be exposed to dripping or splashing and no objects filled with liquids, such as vases, shall be placed on the apparatus.

During Transportation to the Subscriber Home

Transport the LN5000HD in its shipping box or an equally padded container. Do not expose it to rain or moisture.

1 Safety

During Installation

- Do not place LN5000HD in an enclosed area where the cooling vents are blocked or impede the flow of air through the ventilation openings.

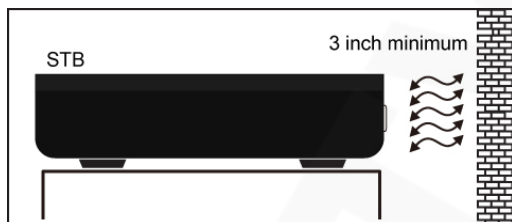

- Install so that its position does not interfere with its proper ventilation. For example, do not place LN5000HD on a bed, sofa, rug, or similar surface that could block the ventilation openings.

CAUTION!



Do not place anything on top of your LN5000HD set-top box, especially other home entertainment components. Be sure to provide adequate ventilation to prevent overheating.

- Install LN5000HD on a hard flat surface not prone to vibration or impact and not on top of another electronic device
- Do not install near any heat sources such as radiators, heat registers, stoves, or other apparatus (including amplifiers) that produce heat.
- Installation of LN5000HD near consumer electronics devices, such as stereo receiver/amplifiers and televisions, is permitted as long as the air surrounding LN5000HD does not exceed 40° C (104° F).
- Do not install LN5000HD in an area where condensation occurs.
- To prevent the temporary loss of guide data and cause a temporarily non-responding LN5000HD, do not plug the AC power cord into a switched power outlet.

1 Safety

FCC COMPLIANCE

Note: This equipment has been tested and found to comply with the limits for a Class B digital device, pursuant to part 15 of the FCC Rules. These limits are designed to provide reasonable protection against harmful interference in a residential installation. This equipment uses and can radiate radio frequency energy and, if not installed and used in accordance with the instructions, may cause harmful interference to radio communications. However, there is no guarantee that interference will not occur in a particular installation. If this equipment does cause harmful interference to radio or television reception, which can be determined by turning the equipment off and on, the user is encouraged to try to correct the interference by one or more of the following measures:

- Reorient or relocate the receiving antenna.
- Increase the separation between the equipment and set-top box.
- Connect the equipment into an outlet on a circuit different from that to which the set-top box is connected.
- Consult the dealer or an experienced radio/TV technician for help.

Caution: Changes or modifications not expressly approved by MaaxTV for compliance could void the user's authority to operate the equipment.

This device complies with part 15 of the FCC Rules. Operation is subject to the following two conditions: (1) This device may not cause harmful interference, and (2) this device must accept any interference received, including interference that may cause undesired operation.

FCC Radiation Exposure Statement

The antennas used for this transmitter must be installed to provide a separation distance of at least 20 cm from all persons and must be co-located for operating in conjunction with any other antenna or transmitter.

2 Appearance

Front Panel



Front Panel

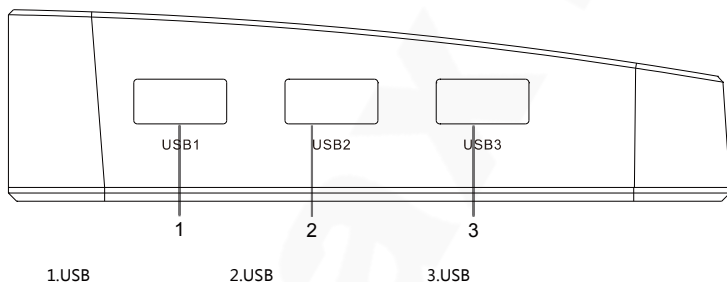

Rear Panel

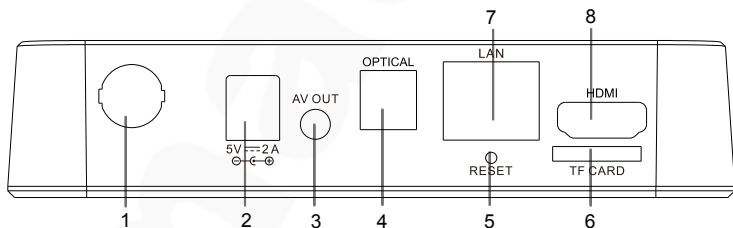

- 1. WiFi antenna
- 2. 5V --- 2A
- 3. A/V out
- 4. Optical fiber out
- 5. Reset key
- 6. TF card
- 7. RJ45 network interface
- 8. HDMI out

3 Rear Panel Connection

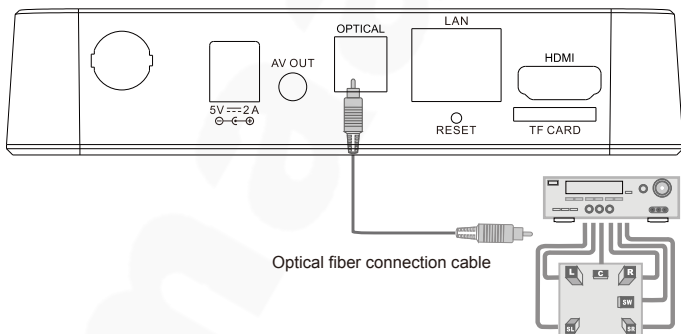
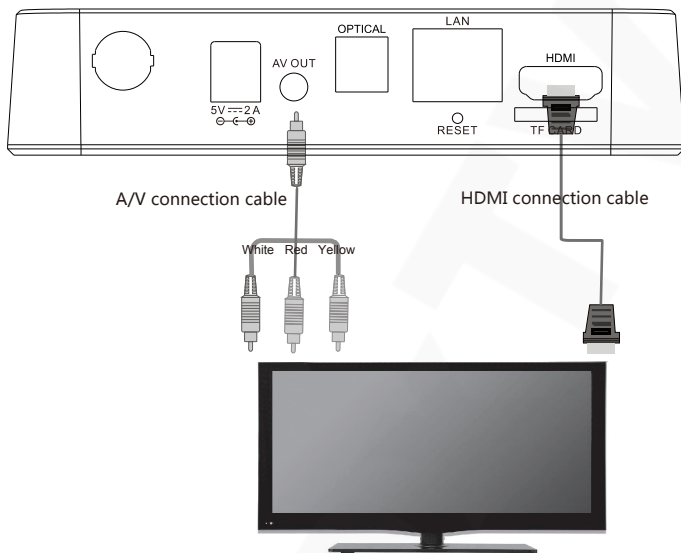

4 Remote



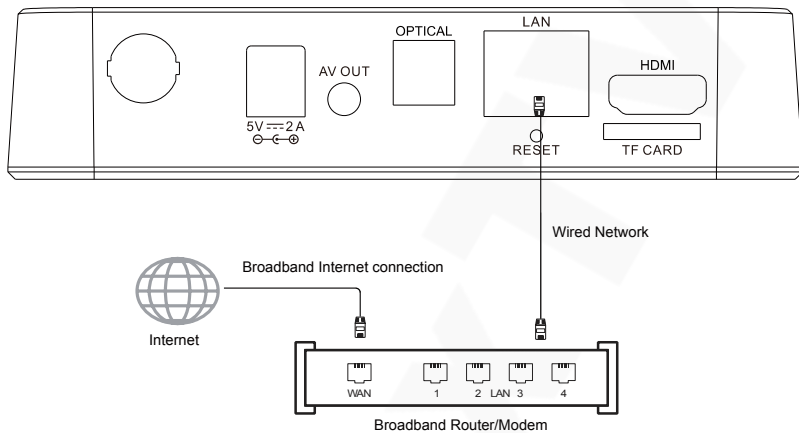



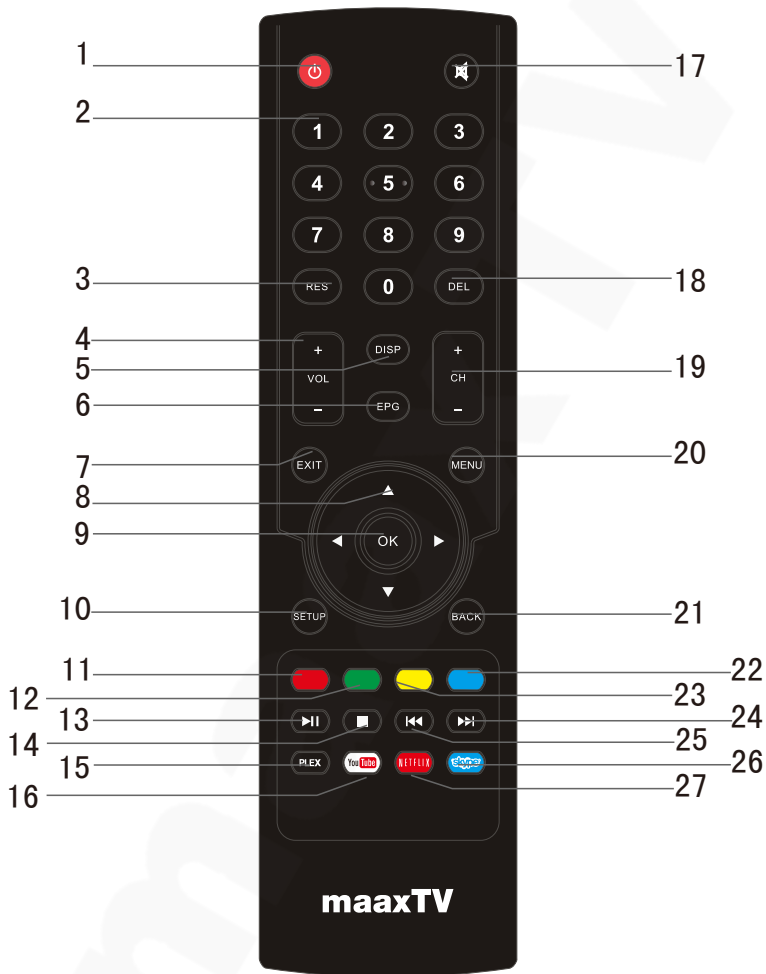



















Rear Panel Connection



4 Remote



4 Remote

No.	Key	Function
1		Go in and out of Standby
2		Numeric input
3		Change the screen resolution on the fly
4		Volume Up/Dn
5		Show additional information when available
6		Show EPG when available
7		Generic exit button. Functionality depends on the application
8		Move left, right, up, down
9		OK
10		Shortcut to the System Setup menu
11		Red button. Functionality depends on the application
12		Green button. Functionality depends on the application
13		Play/Pause
14		Stop
15		Shortcut to the PLEX APP
16		Shortcut to the YouTube APP
17		Mute/Un-Mute sound
18		Multipurpose delete button
19		Channel Up/Dn
20		Shortcut to the Main Menu
21		Back one level
22		Blue button. Functionality depends on the application
23		Yellow button. Functionality depends on the application
24		Skip to next file/Skip to previous file
25		Shortcut to the Skype APP
26		Shortcut to the Netflix APP

5 First Time Set-Up

When operating the box for the first time, you will be asked to set-up a basic set of features that are essential for having a good IPTV experience. Be advised that without a proper internet connection you cannot proceed to the main menu. Chapter 6 describes in detail on how to set-up the network.

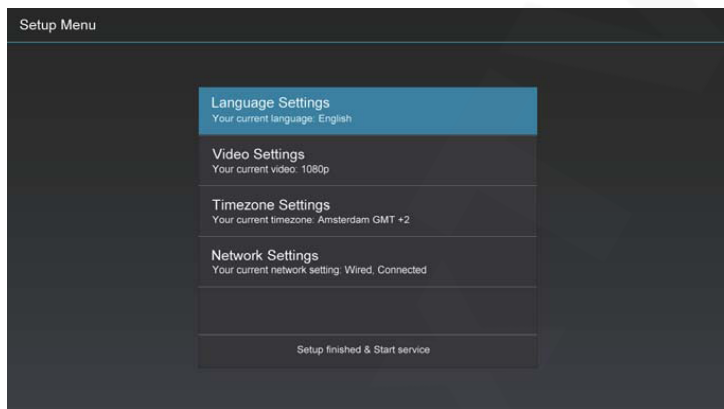

6 Network Settings

6.1 Available Networks and Checking Current Network Status

Check the available guaranteed bandwidth with your ISP.

Recommended bandwidth: To ensure smooth playing of Internet video resources, the bandwidth should be at least 2Mbps.

Router: For easy and quick connection, a wireless router is recommended. A common wireless router can meet the bandwidth requirement for ITPV. The HD509N Set-Top-Box integrates a Wi-Fi module, which can connect to wireless router directly. When you intend to stream high quality movies from internal network, an Ethernet cable connection is recommended.

6.2 Connecting to Cable Network

6.2.1 Connecting to the router

- Connect the network cable to the LAN port of this unit, and connect the other end to the LAN port of the router.
- Turn on the unit, select Settings – Cable Network, check the option “Cable Network” or press OK on the remote control to set this option to “ON”.
- After turning on the cable network, check if the “Cable Network” is selected; if DHCP (Dynamic Host Configuration Protocol) is enabled in the router, this unit will obtain IP address automatically.
- After connecting to the network, the “Cable Network” option shows: Cable network is turned on; IP address, gateway, subnet mask and other information are listed below.

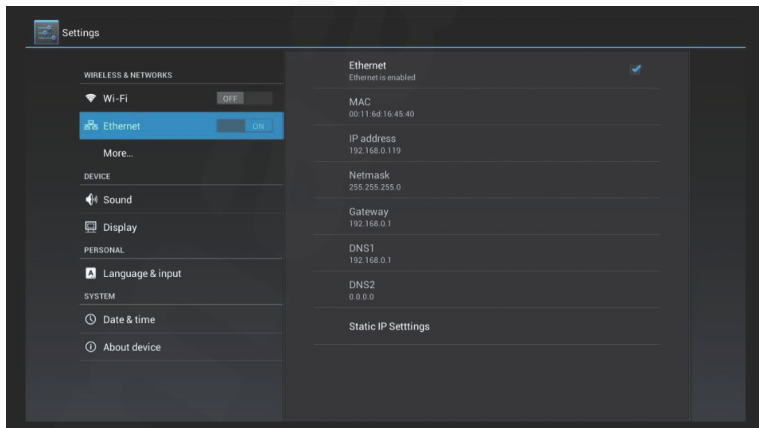

6 Network Settings

6.3 Connecting to Wi-Fi

6.3.1 Connecting to wireless router

- Enter “Settings” in the home screen, select “Wi-Fi” in the left, which has a switch in the right; please turn the switch to “ON” or press OK on the remote control to set this option to “ON”.

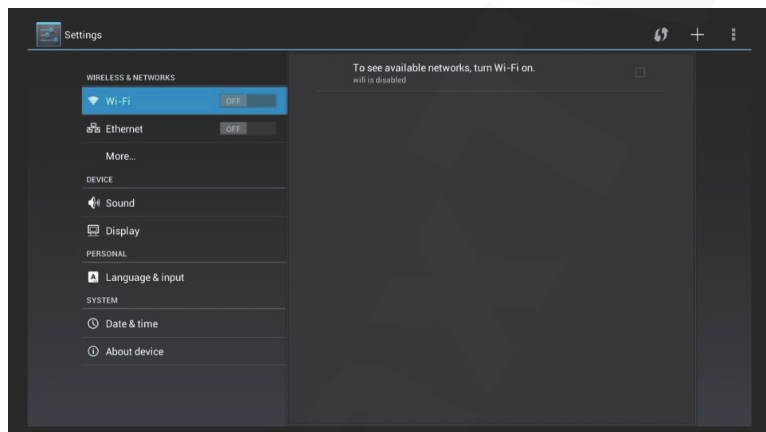

- In the picture below, two Wi-Fi sources are available. The text below the name (SSID) indicates the encryption mode of the Wi-Fi connection. The icon to the right indicates the signal strength . The small lock indicates that the connection is encrypted and password is needed.
- If the wireless network isn't encrypted, you can connect to it directly.
- If the network is encrypted, select the Wi-Fi name to pop up the window for password, press OK on the remote control and call out the soft keypad on the screen, enter the password, select “Next” on the keypad or press the Return key on the remote control to hide the keypad, and then select “Connect” to connect to it. (Note: to hide the keypad on the TV box, press the Return key on the remote control.)

6 Network Settings

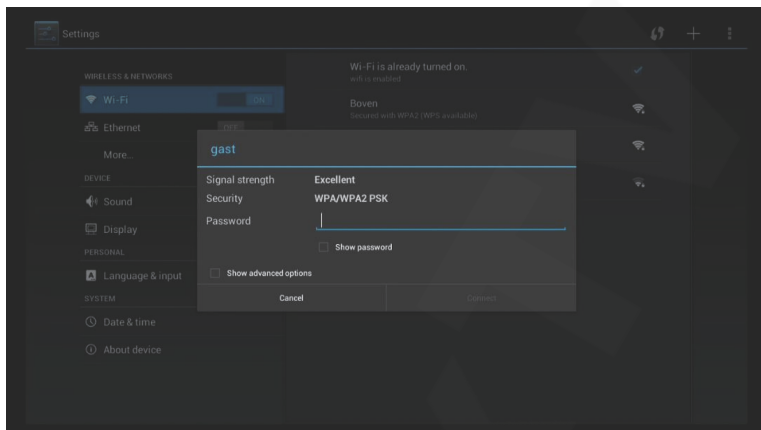

7 Video Settings

7.1 Available Video Interfaces

- **Connecting to TV through HDMI cable**

If the TV set has HDMI interface, the unit can be connected to the TV set with HDMI cable. After connecting, turn on the unit. the LED on the front panel is turned on, the screen shows boot logos and then enters the home screen after several seconds.

- **Connecting to TV through TV cable**

Connect the AV cable to the AV OUT port, connect the yellow video input plug of the TV set to the yellow CVBS video interface, and connect the white and red plug to the left and right audio interfaces respectively. Turn on the TV, switch to AV input mode, turn on the unit, the LED on the front panel is turned on, the screen shows boot logos and then enters the home screen after several seconds.

Note: Not all models come with the special AV cable. Ask your supplier for details.

7.2 Video Output Settings

7.2.1 Resolution settings

Before operating for the first time, please adjust the screen resolution to achieve the optimal display: In Settings, enter Display - Output Resolution:

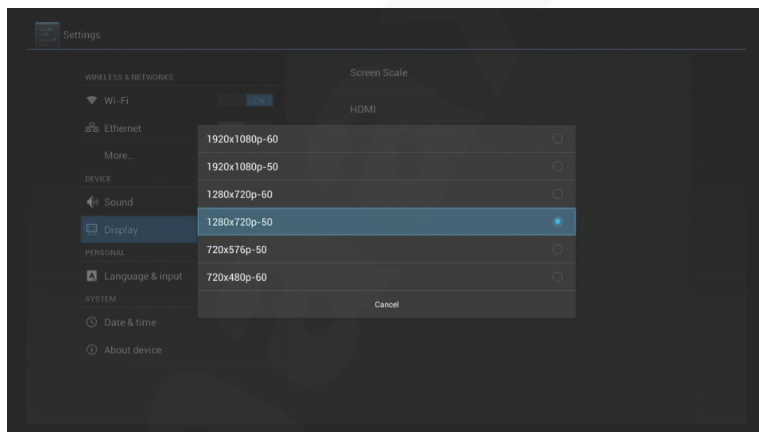

This option is mainly intended for HDMI interface output.

If AV port output is used, enter Display - AV Output to set.

Note: When the selected resolution is not supported by TV-Set, the system will automatically return to the latest good resolution. As an extra safety net, the "RES" button on the remote control can be used at all times to change the resolution without having visual contact with the setting menu.

7 Video Settings

7.2.2 Screen size settings

After adjusting the resolution, the screen edges will be cut or have black borders. Enter Settings - Display - Aspect Ratio, and press the Left/Right key on the remote control in the aspect ratio window and adjust.

Tips: Zoom out the screen to the smallest (adjust the slider to the left), and then zoom in the screen (adjust the slider to the right), check the screen edges, and it is optimal when the screen edges coincide with the TV edges.

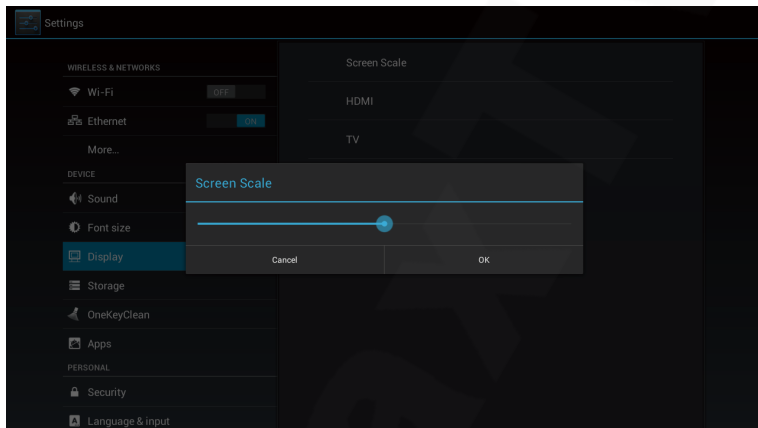

8 Specifications

Interfaces	HDMI
	3 x USB
	Optical
	LAN
	Wi-Fi
	AV
	TF CARD slot
Power supply	5V/2A
Dimensions	150x105x28mm
Net Weight	0.3kg
Gross Weight	0.6kg

9 Disclaimer

This is an original work by Filotel S.A. and is protected by applicable copyright laws worldwide. Neither the whole nor any part of this work may be reproduced, stored, adapted or transmitted, published, modified in any form or by any means whatsoever, mechanical, electronic, photographic, graphic, optic recording or otherwise, translated into any language or computer language, without the prior written permission of Filotel S.A.

Unless by way of a separate agreement, Filotel S.A. makes no representations or warranties with respect to the contents hereof, including their accuracy and error-free nature, and shall not be responsible for any loss or damage caused to the user by the direct or indirect use of this information. Furthermore, Filotel S.A. reserves the right to use the subject matter of this notice in any manner whatsoever, with no obligation to notify the recipient of the subject matter of any changes made hereto. All products referenced herein are trademarks of the company and/or of those referenced.

Copyright© 2014 Filotel S.A.

Terms of use

All terms of use are stated at www.maaxtv.com/termsfuse